 <p>Panasonic ideas for life</p>	<p>ULTRA SMALL HIGH RELIABILITY DETECTION SWITCHES</p>	<p>FT-μ (ABC2) SWITCHES</p>
---	---	---

FEATURES

- **Ultra-low profile 1.4 mm .055 inch** (3.4 × 3.5 × 1.4 mm) (.134 × .138 × .055 inch)
- **The coil spring serves as the contact and a high contact reliability is achieved by the more than adequate contact force and wiping effect. By adopting gold-clad contact, a high contact reliability is also achieved under a small current, voltage and load.**
- **Horizontal and vertical mounting types are available and detecting from horizontal and vertical directions is possible.**
- **High overtravel (1.3 mm .051 inch) makes it easy for installation. (Long stroke type)**

TYPICAL APPLICATIONS

- 1. Digital audio visual equipment**
 - DVC (digital video camera)
 - DSC (digital still camera)
- 2. Personal computer and its peripherals**
 - Notebook PC
 - CD-ROM/CD-R, RW
 - DVD (digital versatile disc)
- 3. Digital compact equipment**
 - Mobile phone
 - PDA (personal digital assistant)
 - MD (Mini Disc)
- 4. Others**
 - IC card and other electronic money-related products

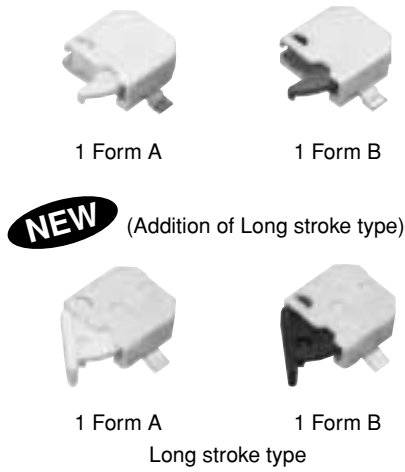

ORDERING INFORMATION





Type of switch	Contact arrangement	Terminal shape	Operating direction	Packing style
2: FT- μ switches	1: SPST-NO (1 Form A) 2: SPST-NC (1 Form B) 3: Long stroke type SPST-NO (1 Form A) 4: Long stroke type SPST-NC (1 Form B)	0: Standard type (without positioning boss) 1: Standard type (with positioning boss) 2: Low profile type 3: Vertical type	1: Right angle type 2: Left angle type (standard type only) 3: Vertical detection type	P : Embossed tape packing (standard type) P1: Upside-down embossed tape packing (Low profile type only) P2: Embossed tape packing (vertical type)

Remark: The actuator colors of 1 Form A type is ivory and 1 Form B type is black.

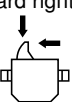
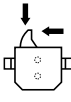
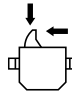
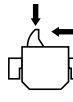
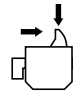
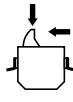
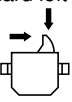
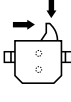
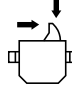
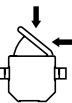
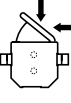
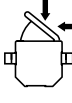
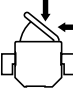
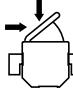
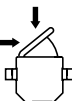
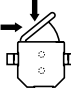
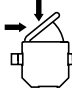
PRODUCT LINEUP

Detection direction	Standard type		Low Profile type		Vertical type
	With positioning boss	Without positioning boss	Standard embossed tape packing	Upside-down embossed tape packing	
Standard right angle 					
Standard left angle 			—	—	—
Long stroke right angle 					—
Long stroke left angle 			—	—	—

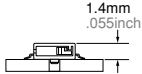
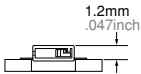
MOUNTING VIEW

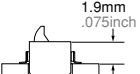
	Standard type	Low Profile type		Vertical type
		Standard embossed tape packing	Upside-down embossed tape packing	
Mounting part layout				

PRODUCT TYPES

1) Standard type

Contact arrangement	Detection direction	Packing style	Standard type		Low Profile type		Vertical type
			With positioning boss	Without positioning boss	Standard embossed tape packing	Upside-down embossed tape packing	
1 Form A	Right angle	Embossed tape *(4,000 pcs./reel)	ABC2111P	ABC2101P	ABC2121P	ABC2121P1	ABC2133P2
	Left angle		ABC2112P	ABC2102P	—	—	—
1 Form B	Right angle		ABC2211P	ABC2201P	ABC2221P	ABC2221P1	ABC2233P2
	Left angle		ABC2212P	ABC2202P	—	—	—

* Vertical type: 2,000 pcs./reel

1) Long stroke type

Contact arrangement	Detection direction	Packing style	Standard type		Low Profile type		Vertical type
			With positioning boss	Without positioning boss	Standard embossed tape packing	Upside-down embossed tape packing	
1 Form A	Right angle	Embossed tape (4,000 pcs./reel)	ABC2311P	ABC2301P	ABC2321P	ABC2321P1	—
	Left angle		ABC2312P	ABC2302P	—	—	—
1 Form B	Right angle		ABC2411P	ABC2401P	ABC2421P	ABC2421P1	—
	Left angle		ABC2412P	ABC2402P	—	—	—

CONTACT ARRANGEMENT: SPST-NO (1 Form A), SPST-NC (1 Form B)

SPECIFICATIONS

1. Contact rating

0.01 mA 5V DC to 10 mA 5V DC (resistive load)

2. Characteristics

	1 Form A type	1 Form B type
Electrical life	Min. 10 ⁵ (10 mA 5V DC, 0.01 mA 5V DC contact opening 20 cpm)	Min. 5 × 10 ⁴ (10 mA 5V DC, 0.01 mA 5V DC contact opening 20 cpm)
Insulation resistance	Min. 100 MΩ (by 100V DC insulation resistance meter)	
Dielectric strength	100 Vrms for 1 min. (Between uncontinuous terminals)	
Contact resistance (initial)	Max. 3Ω (by voltage drop at 10 mA 5V DC)	
Vibration resistance	15 m/s ² 10 to 500Hz (Contact opening: max. 1 msec.)	
Shock resistance	300 m/s ² (Contact opening: max. 1 msec.)	
Allowable operating speed	30 to 300mm/s	
Allowable operating frequency	60 times/min. (at no load)	
Ambient temperature	-25 to 80°C -13 to 176°F Not freezing nor condensing	

3. Operating characteristics

1) Standard type

Item	Standard type		Low profile type	Vertical type
	With positioning boss	Without positioning boss		
Free position (F.P.) (mm inch)	2.7 ^{+0.3} _{-0.1} .106 ^{+0.12} _{-.004}	4.8 ^{+0.3} _{-0.1} .189 ^{+0.12} _{-.004}	4.8 ^{+0.3} _{-0.1} .189 ^{+0.12} _{-.004}	3.3 ^{+0.3} _{-0.1} .130 ^{+0.12} _{-.004}
Operating position (O.P.) (mm inch)	2.3±0.3 .091±.012	4.4±0.3 .173±.012	4.4±0.3 .173±.012	2.9±0.3 .114±.012
Total travel position (T.T.P.) (mm inch)	1.3±0.1 .051±.004	3.4±0.1 .134±.004	3.4±0.1 .134±.004	1.9±0.15 .075±.006
Operating force, Max. (N)	0.3	0.3	0.3	0.3

2) Long stroke type

Item	Standard type		Low profile type	Vertical type
	With positioning boss	Without positioning boss		
Free position (F.P.) (mm inch)	3.5 ^{+0.3} _{-0.1} .138 ^{+0.12} _{-.004}	5.6 ^{+0.3} _{-0.1} .220 ^{+0.12} _{-.004}	5.6 ^{+0.3} _{-0.1} .220 ^{+0.12} _{-.004}	—
Operating position (O.P.) (mm inch)	3.0±0.3 .118±.012	5.1±0.3 .201±.012	5.1±0.3 .201±.012	—
Total travel position (T.T.P.) (mm inch)	1.7±0.1 .067±.004	3.8±0.1 .150±.004	3.8±0.1 .150±.004	—
Operating force, Max. (N)	0.3	0.3	0.3	—

DIMENSIONS

mm inch General tolerance: $\pm 0.15 \pm 0.06$

1. Standard type

(Right angle type with positioning boss)

Recommended PC board pattern

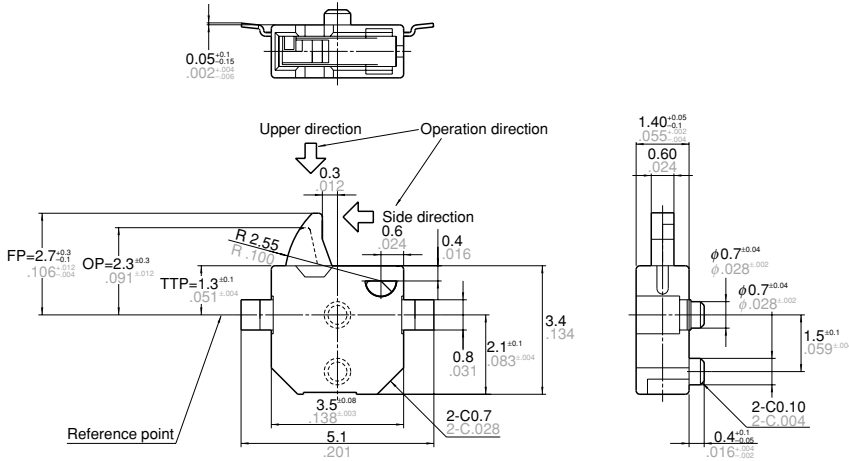

(Right angle type without positioning boss)

Recommended PC board pattern

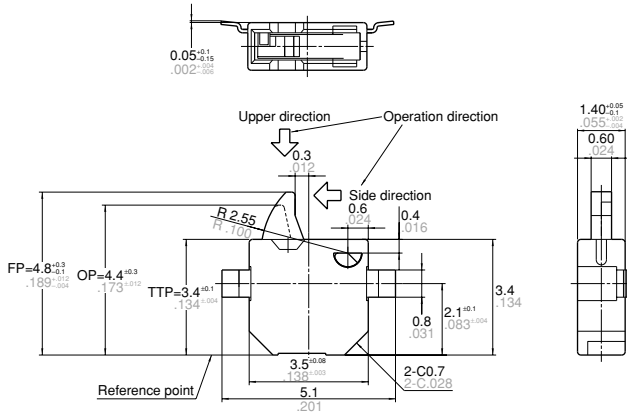

(Left angle type with positioning boss)

Recommended PC board pattern

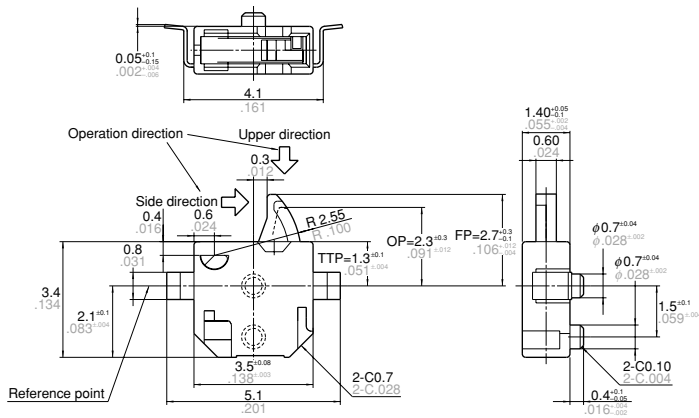

(Left angle type without positioning boss)

mm inch General tolerance: $\pm 0.15 \pm .006$

Recommended PC board pattern

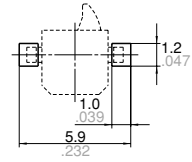
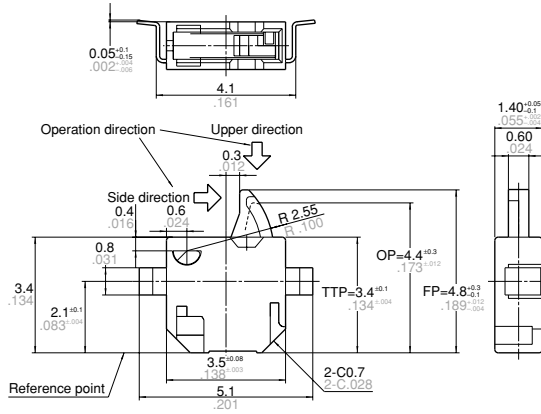

• Low profile type

Recommended PC board pattern

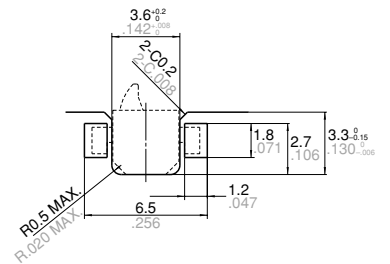
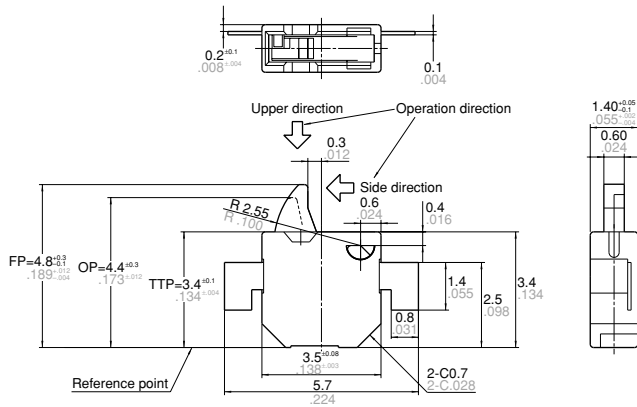

• Vertical type

mm inch General tolerance: $\pm 0.15 \pm .006$

Recommended PC board pattern

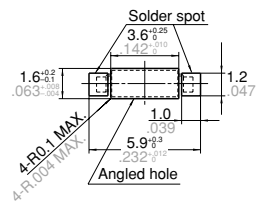
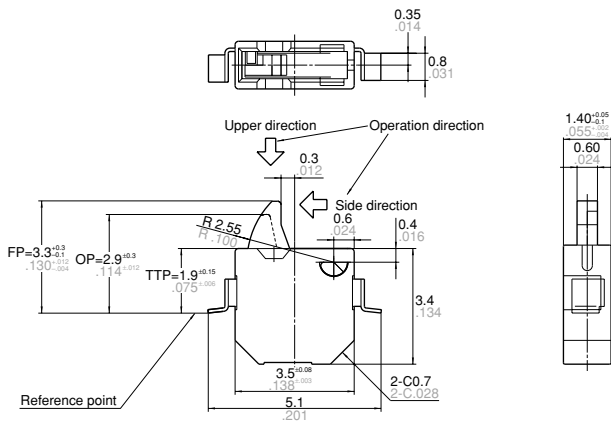

2. Long stroke type

(Right angle type with positioning boss)

mm inch General tolerance: $\pm 0.15 \pm 0.06$

Recommended PC board pattern

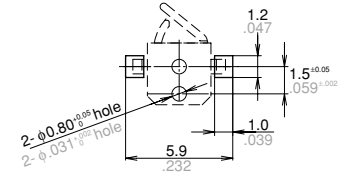
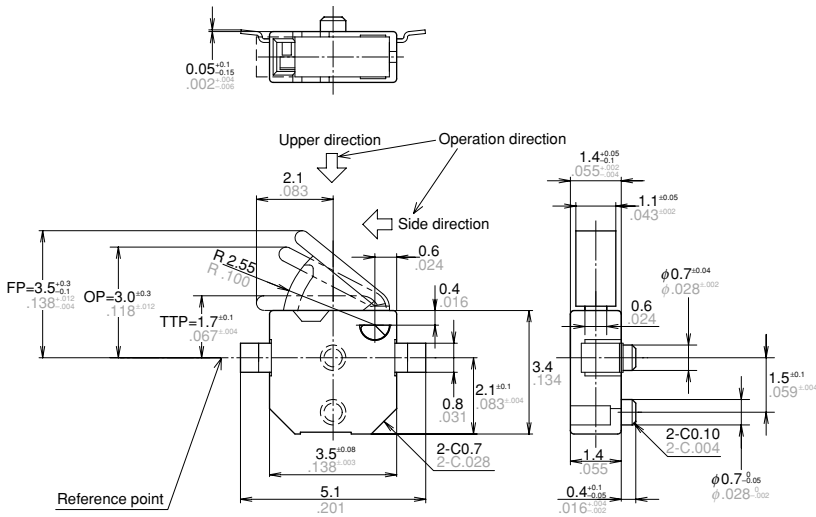

(Right angle type without positioning boss)

Recommended PC board pattern

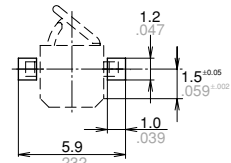
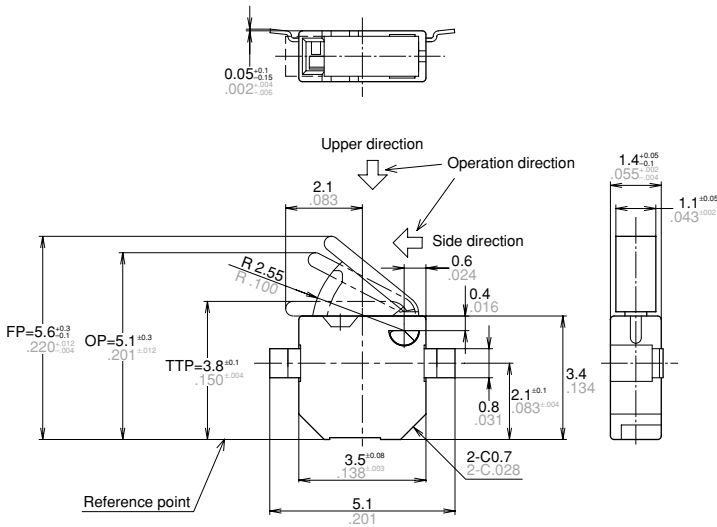

(Left angle type with positioning boss)

Recommended PC board pattern

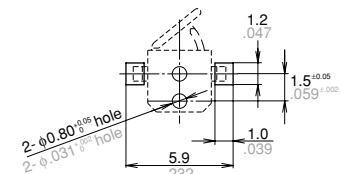
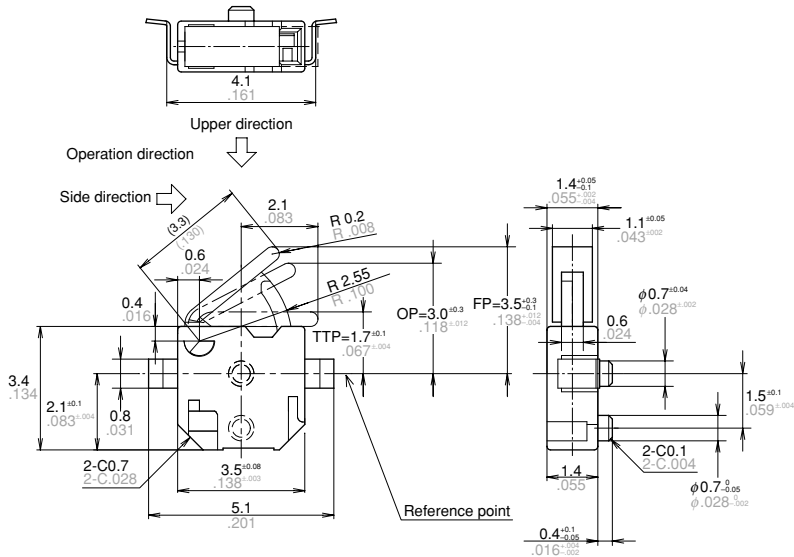

(Left angle type without positioning boss)

mm inch General tolerance: $\pm 0.15 \pm .006$

Recommended PC board pattern

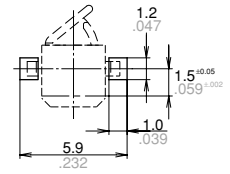
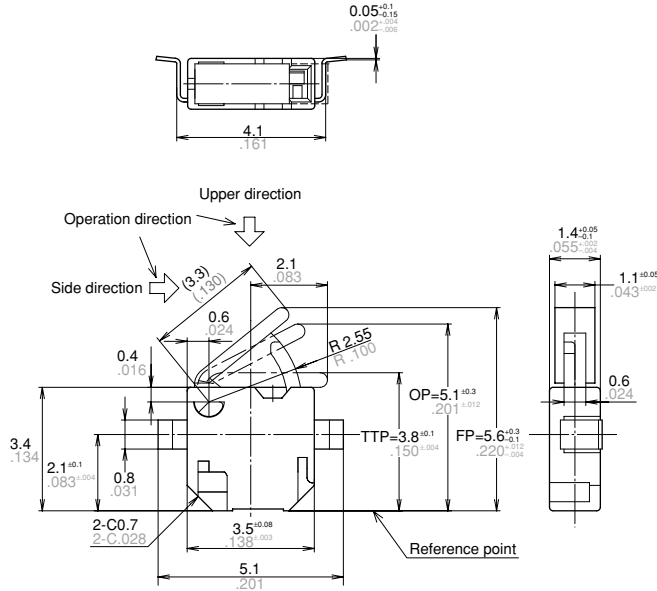

• Low profile type

Recommended PC board pattern

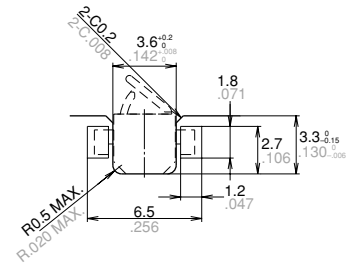
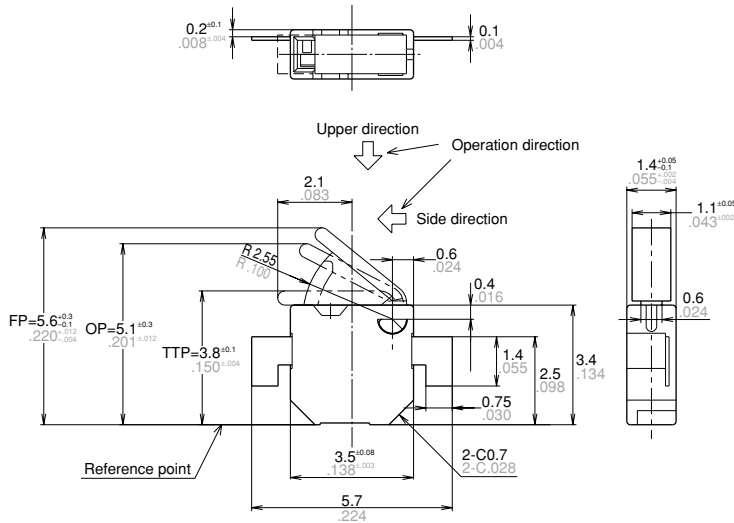

NOTES

1. Mounting

- 1) The positioning of the switch should be such that the pushbutton for the switch should not directly apply force to the operating section in the free condition.
- 2) During both mounting and operation, care must be taken to protect the pushbutton from excessive stress, as this may cause malfunctioning.
- 3) During mounting, the insulation distance between ground and each terminals should be confirmed as sufficient.

2. Soldering

- 1) For manual soldering; Iron tip temperature max. is 320°C 608°F and soldering should be completed within 3 seconds.
- 2) For reflow soldering; Perform soldering reflow at a peak surface temperature of the PC board not to exceed 245°C 473°F.
- 3) For cream soldering; Screen thickness is recommended between 0.10 to 0.15 mm .004 to .006 inch.
- 4) During soldering, care should be taken not to apply excessive stress to the terminals as the resulting deformation may cause malfunction.
- 5) Excessively high solder tab temperature and soldering iron wattage should also be avoided as these factors may harm switching performance.
- 6) As this switch is thin, using flux should be avoided for the reason of the flux may come inside of the switch and cause damage.

3. Switch operations

- 1) The installation position of the activating unit that operates the switch should be set at a distance of 1.4 to 1.9 mm .055 to .075 inch from the center of the positioning projection for the type with boss (1.8 to 2.6 mm .071 to .102 inch for long stroke

type) and at a distance of 3.5 to 4.0 mm .138 to .157 inch from the bottom for the low profile type without (3.9 to 4.7 mm .154 to .185 inch for long stroke type).

- 2) For 1 Form B contact type operation, set the pushbutton so it returns to the free position.
- 3) Avoid using the switch as a stopper since it may cause trouble with the operations.
- 4) When using the switch to operate in the sideways direction, ensure that the corner roundness of the operating unit is more than R1.

4. Environment

- 1) These switches do not have a sealed construction. As such, the construction of the equipment in which the switches are to be installed should be given careful consideration when the switches are to be used in locations where corrosive gases, silicon or other substances which will adversely affect the contacts are used, where there is a high concentration of dust or where the switches may be exposed to condensation or water. Using switches in locations like these may cause malfunctioning.
- 2) Avoid using this switch in high-temperature, high-humidity or condensation-forming environments and avoid allowing droplets of water to remain on the switch or come into contact with it. These conditions may interfere with the performance of the switch (resulting in short-circuiting, etc.). Use the type with the gold contacts in applications involving trains, aircraft, motor vehicles or medical equipment where the switch must satisfy safety and high reliability requirements. Please consult with us for the applications required

high reliability.

- 3) Because the humidity range differs depending on the ambient temperature, the humidity range indicated below should be used. Continuous operation of the switch is possible within this range, but continuous use near the limit of the range should be avoided.

• This humidity range does not guarantee permanent performance.

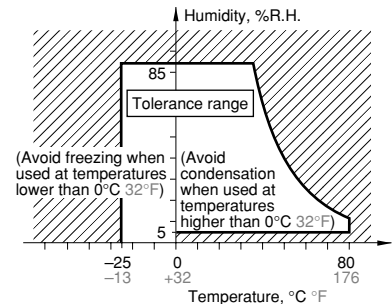
**5. Quality check under actual loading conditions**

- 1) Consult with us if this switch is to be used outside its ratings.
- 2) To improve reliability, check the switch under actual loading conditions.

6. Breakdown mode

For the switch breakdown mode, shorts, open circuits, or rises in temperature should be considered. For a device to be safe so that it does not create any adverse effect, ensure that a protection circuit or protection device is in place to protect against a possible switch failure. Also, please make sure that sufficient redundancy is built into the system in order to ensure safety.